

- > Ø 8 ... 63 mm
- > Saves 20% space over the basic length of a corresponding ISO/VDMA cylinder
- > Low friction, long life seals
- > High strength, double crimped end cap design
- > Standard magnetic piston for full control system versatility

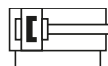

Technical features

Medium:

Compressed air, filtered, lubricated or non-lubricated

Operation:

Double acting with buffer cushioning

Operating pressure:

1 ... 10 bar (14 ... 145 psi)

Cylinder diameters:

8, 10, 12, 16, 20, 25, 32, 40, 50, 63 mm

Strokes:

See page below

Non-standard strokes:

up to 500 mm max. on request

Operating temperature:

+80°C max. (+176°F)

Air supply must be dry enough to avoid ice formation at temperatures below +2°C (+35°F).

Materials:

Piston rod: stainless steel (8 ... 16 mm bore austenitic, 20 ... 63 mm bore martensitic)
End covers: aluminium
Barrel: stainless steel (austenitic)
Wiper: PUR
Seals and 'O'-rings: NBR

Technical data

Cylinder Ø (mm)	8	10	12	16	20	25	32	40	50	63
Port size RT/572** (RM/572**)	M3 (M3)	M5 (M5)	M5 (M5)	M5 (M5)	Rc 1/8 (M6)	Rc 1/8 (M6)	Rc 1/8 (G 1/8)	Rc 1/8 (G 1/8)	Rc 1/4 (G 1/4)	Rc 1/4 (G 1/4)
Piston rod Ø (mm)	3	4	4	6	8	10	12	14	16	20
Piston rod thread	M3	M4	M4	M6	M8	M10 x 1,25	M10 x 1,25	M12 x 1,25	M 12 x 1,25	M 16 x 1,5
Theoretical thrusts at 6 bar outstroke (N)	30	46,8	67,8	120	188	294	482	754	1178	1870
Theoretical thrusts at 6 bar instroke (N)	25,9	39,6	60	103	158	247	414	661	1057	1680
Air consumption at 6 bar outstroke (l/cm)	0,004	0,005	0,008	0,014	0,022	0,035	0,056	0,087	0,137	0,218
Air consumption at 6 bar instroke (l/cm)	0,003	0,004	0,006	0,013	0,019	0,02	0,048	0,074	0,114	0,195

Standard strokes

Cylinder Ø (mm)	Stroke length (mm)										
	10	25	40	50	80	100	125	160	200	250	320
8	•	•	•	•	•	•	—	—	—	—	—
10	•	•	•	•	•	•	—	—	—	—	—
12	•	•	•	•	•	•	•	•	•	—	—
16	•	•	•	•	•	•	•	•	•	—	—
20	•	•	•	•	•	•	•	•	•	•	•
25	•	•	•	•	•	•	•	•	•	•	•
32	•	•	•	•	•	•	•	•	•	•	•
40	•	•	•	•	•	•	•	•	•	•	•
50	•	•	•	•	•	•	•	•	•	•	•
63	•	•	•	•	•	•	•	•	•	•	•

Cylinder variants

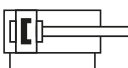
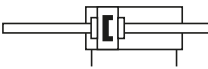
Symbol	Model magnetic piston	Description	Dimensions
			Page
	R./57200/M	Standard cylinder, Ø 8 to 40 mm, integral eye mounting, Ø 50 and 63 mm	4 & 5
	R./57200/MC	Cylinder with central rear port	5
	R./57200/MF	Cylinder with flat rear cover	5
	R./57200/JM	Cylinder with double ended piston rod (Ø 16 to 63 mm)	4

Option selector



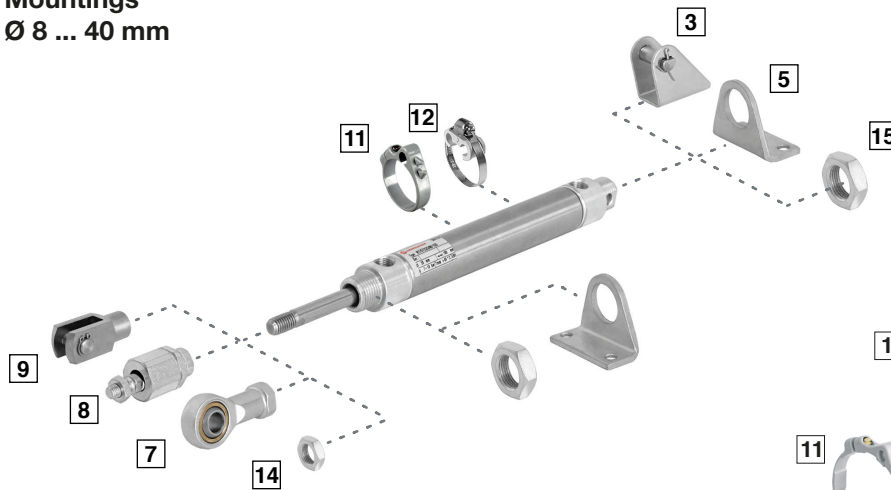
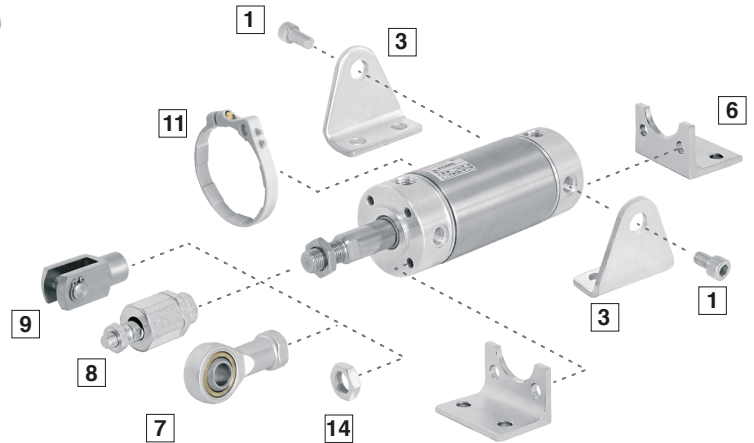

R★/572★★/★★/★★★

Port size	Cylinder Ø (mm)	Substitute
M3	8	T
M5	10	T
M5	12	T
M5	16	T
M6	20	M
Rc1/8	20	T
M6	25	M
Rc1/8	25	T
G1/8	32	M
Rc1/8	32	T
G1/8	40	M
Rc1/8	40	T
G 1/4	50	M
Rc 1/4	50	T
G 1/4	63	M
Rc 1/4	63	T

Stroke (mm)	
500 max.	
Cylinder variants	Substitute
Magnetic piston	M
Magnetic piston, central rear port, flat end	MC
Magnetic piston, side port, flat end	MF
Magnetic piston, double ended piston rod	JM
Cylinder Ø (mm)	Substitute
8	08
10	10
12	12
16	16
20	20
25	25
32	32
40	40
50	50
63	63

**Mountings
Ø 8 ... 40 mm**

Ø 50 and 63 mm

Cyl.	AK	C	F	H	L	N
						
	8	5	9	1	3	15
	Page 6	Page 6	Page 6	Page 6	Page 6	Page 7
8	—	M/P71273/1	QM/57008/25	—	QM/57008/24	M/P71364
10	QM/8010/38	M/P71273/2	QM/8010/25	—	QM/947	M/P71364
12	QM/8010/38	M/P71273/2	QM/8010/25	—	QM/947	M/P71364
16	QM/8012/38	M/P19369	QM/57016/25	—	QM/946	M/P1501/90
20	QM/8020/38	M/P19389	QM/57020/25	—	QM/8012/24	M/P13834
25	QM/8025/38	M/P40381	QM/57025/25	—	QM/57025/24	M/P13607
32	QM/8025/38	M/P19406	QM/57032/25	—	QM/8020/24	M/P13615
40	QM/8040/38	M/P71273/3	QM/57040/25	—	QM/57040/24	M/P29254
50	QM/8040/38	QM/57050/21	QM/57040/25	QM/55240/28	QM/57050/24	—
63	QM/8050/38	QM/57063/21	QM/57063/25	QM/55250/28	QM/57063/24	—

Cyl.	N2	UF	Switch mounting brackets >15 mm stroke	<15 mm stroke	Magnetically operated switches
					
	14	7	11	12	
	Page 7	Page 7	Page 7	Page 7	Page 8 & 9
8	M/P1500/111	—	—	—	
10	M/P1501/80	QM/8010/32	QM/33/010/22	QM/33/010/23	
12	M/P1501/80	QM/8010/32	QM/33/012/22	QM/33/016/23	
16	M/P1501/79	QM/8012/32	QM/33/016/22	QM/33/016/23	
20	M/P1501/60	QM/8020/32	QM/33/020/22	QM/33/020/23	
25	M/P1501/89	QM/8025/32	QM/33/025/22	QM/33/025/23	
32	M/P1501/89	QM/8025/32	QM/33/032/22	—	
40	M/P1501/90	QM/8040/32	QM/33/040/22	—	
50	M/P1501/90	QM/8040/32	QM/33/050/22	—	
63	M/P1501/91	QM/8050/32	QM/33/063/22	—	

Basic dimensions

Dimensions in mm
Projection/First angle

Ø 8 ... 12 mm - RT/572../M

RT/572../MC

RT/572../MF

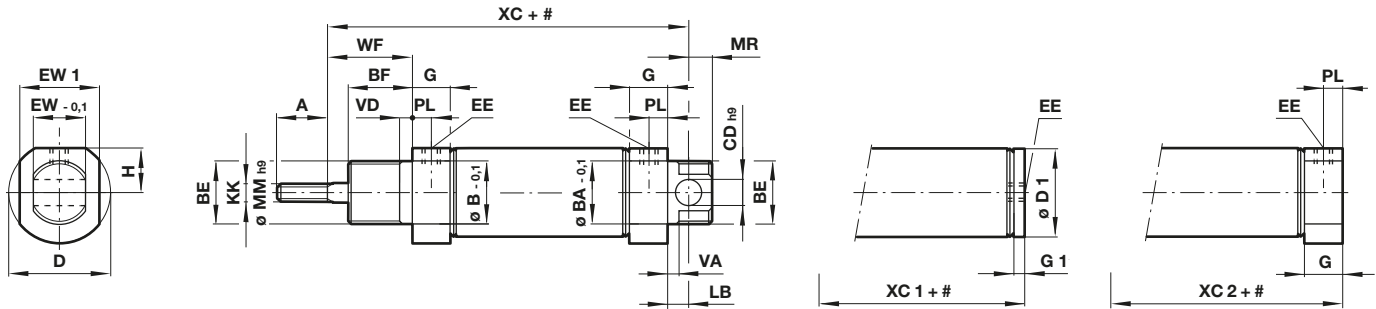

Ø 16 ... 40 mm - R./572../M

R./572../MC

RT/572../MF

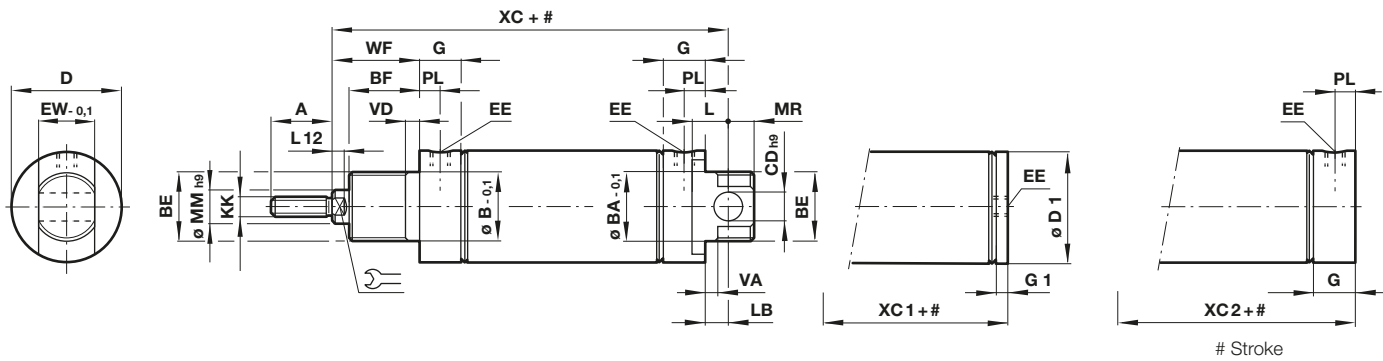

Ø	A	Ø B/Ø BA	BE	BF	Ø CD h9	Ø D	Ø D1	RT/5... EE	RM/5... EE	EW -0,1	EW1	G	G1	H	KK	L
8	8	10	M10 x 1	7,5	3	12	9,5	M3	M3	6	10	7,5	3	5	M3	-
10	9	10	M10 x 1	8	4	15	11,5	M5	M5	8	12,5	9,5	4,5	6,5	M4	-
12	9	10	M10 x 1	8	4	15	13	M5	M5	8	-	9,5	4,5	6,5	M4	-
16	12	12	M12 x 1,25	10	5	17,5	17,5	M5	M5	10	-	11,5	4	-	M6	-
20	14	16	M16 x 1,5	12	6	22	21,5	Rc 1/8	M6	12	-	15,5	8	-	M8	-
25	16	18	M18 x 1,5	12	8	26,5	26,5	Rc 1/8	M6	14	-	15,5	8	-	M10 x 1,25	-
32	22	22	M22 x 1,5	15	8	33,5	33,5	Rc 1/8	G 1/8	16	-	17,5	5,5	-	M10 x 1,25	12
40	23	30	M30 x 1,5	15	10	41,5	41,5	Rc 1/8	G 1/8	20	-	18	5,5	-	M12 x 1,25	14

Ø	LB	L12	Ø MM h9	MR	PL		VA/VD	WF	XC	XC1	XC2	kg at 0 mm	kg per 25 mm	Model
8	4,5	-	3	3	4	-	1,5	8,5	48	39	43,5	0,02	0,02	RT/57208/M*
10	5	-	4	4	5,5	-	1,5	10	54	44	49	0,02	0,03	RT/57210/M*
12	5	-	4	4	5,5	-	1,5	10	54	44	49	0,02	0,03	RT/57212/M*
16	7	5	6	5	5,5	5	2	13,5	64,5	50	57,5	0,04	0,05	RT/57216/M*
20	7	5	8	6	9	7	3	15,5	75,5	61	68,5	0,08	0,07	R./57220/M*
25	9	5	10	8	9	9	3	16,5	78,5	62	69,5	0,12	0,11	R./57225/M*
32	7	5	12	8	9	10	3	23	93	74	86	0,21	0,16	R./57232/M*
40	5	6	14	10	10	12	3	24	96	78,5	91	0,33	0,20	R./57240/M*

* Please insert standard stroke length.

Ø 50 and 63 mm - R./57200/M

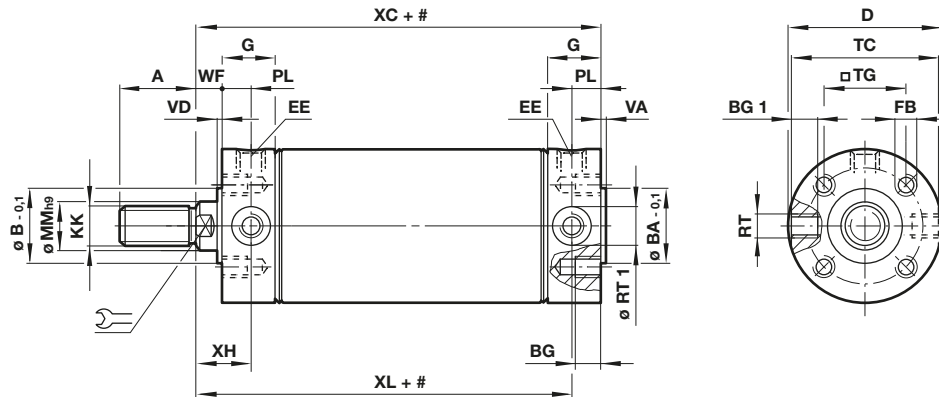
 Dimensions in mm
Projection/First angle

Ø	A	Ø B/BA -0,1	BG	BG 1	Ø D	RT/57... EE	RM/57... EE	FB	G	KK	Ø MM h9	PL
50	23	28	12	8	52,5	Rc 1/4	G 1/4	M 6	22	M 12 x 1,25	16	13
63	30	35	12	9,5	65,5	Rc 1/4	G 1/4	M 8	22	M 16 x 1,5	20	13

Ø	RT	RT 1	SW	TG	TC	VA/VD	WF	XH	XL	kg at 0 mm	kg per 100 mm	Model
50	M 10 x 1	13	13	28,5	49	2	13	26	84	0,39	0,31	R./57250/M*
63	M 12 x 1,5	15	17	35,5	62	2	13	26	86	0,89	0,44	R./57263/M*

* Please insert standard stroke length.

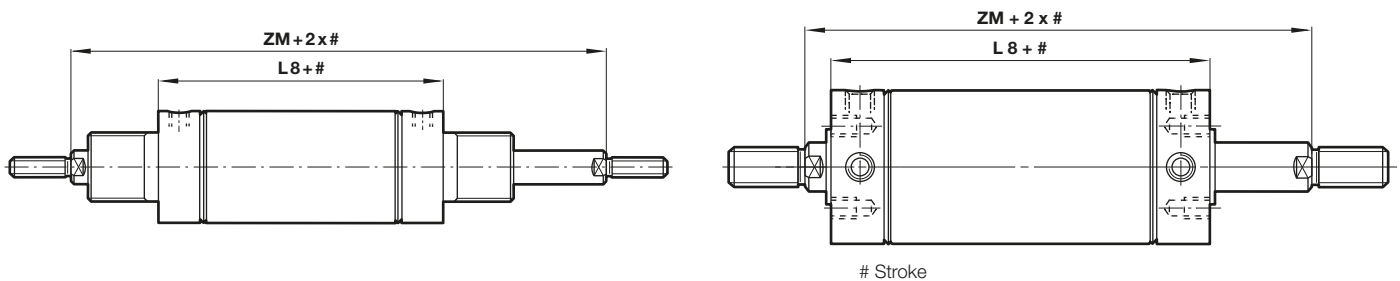
Ø 16 ... 63 mm - R./57200/JM

Ø	L8	ZM	Model
16	44	71	R./57216/JM*
20	53	84	R./57220/JM*
25	53	86	R./57225/JM*
32	63	109	R./57232/JM*
40	67	115	R./57240/JM*
50	84	110	R./57250/JM*
63	86	112	R./57263/JM*

* Please insert standard stroke length.

Mountings

Piston rod swivel AK

Conforms to DIN ISO 8139

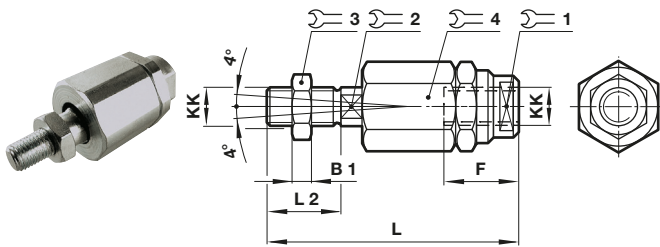

Ø	KK	B1	F	L	L2	Swivel				kg	Model (AK)
						1	2	3	4		
10/12	M 4	2	12,5	33	8	11	3,2	7	11	0,01	QM/8010/38
16	M 6	3	14	39	12	7	5	10	13	0,02	QM/8012/38
20	M 8	4	18	55	16	10	7	13	17	0,05	QM/8020/38
25/32	M 10x1,25	5	26	73	20	19	12	17	30	0,20	QM/8025/38
40/50	M 12x1,25	6	26	77	24	19	12	19	30	0,20	QM/8040/38
63	M 16x1,5	8	34	106	32	30	19	24	42	0,65	QM/8050/38

Foot C

Conforms to DIN ISO 6432

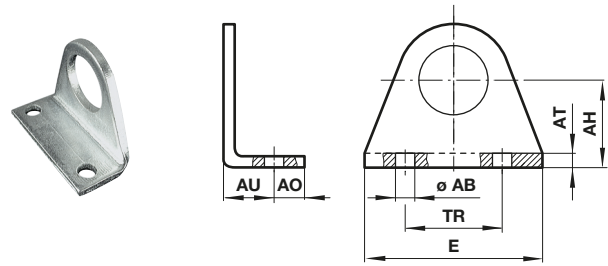

Ø	Ø AB	AH	AO	AT	AU	E	TR	kg	Model (C)
8	3,8	10	3,5	1,5	7,5	25	18	0,01	M/P71273/1
10/12	5	12	4,5	1,5	7,5	30	20	0,01	M/P71273/2
16	4,5	16	6	2	10	35	25	0,02	M/P19369
20	5,5	20	6	3	13	43	32	0,03	M/P19389
25	6,6	22	8	3	12,5	49	38	0,04	M/P40381
32	6,6	25	7,5	4	16	53	40	0,06	M/P19406
40	7	28	7	4	16	66	52	0,08	M/P71273
50	9	40	10	4	17	52	36	0,18	QM/57050/21
63	9	47	10	5	19	61	45	0,28	QM/57063/21

Piston rod clevis F

Conforms to DIN ISO 8140

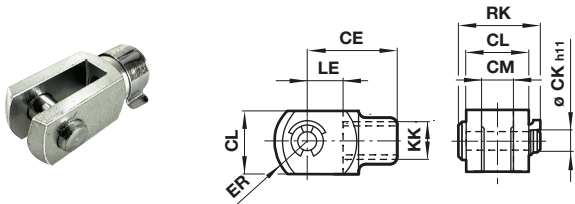

Ø	KK	CE	Ø CK h11	CL	CM	ER	LE	RK	kg	Model (F)
8	M3	11	3	6	3	4,5	5	10,5	0,01	QM/57008/25
10/12	M4	16	4	8	4	6,5	8	11,5	0,01	QM/8010/25
16	M6	20	5	10	5	8	10	14,5	0,01	QM/57016/25
20	M8	24	6	12	6	9,5	12	17,5	0,02	QM/57020/25
25	M10x1,25	26	8	14	7	11,5	12	20,5	0,04	QM/57025/25
32	M10x1,25	32	8	16	8	13	16	22,5	0,05	QM/57032/25
40/50	M12x1,25	40	10	20	10	16	20	29	0,09	QM/57040/25
63	M 16x1,5	56	14	27	14	21	28	36,5	0,20	QM/57063/25

Rear hinge L

for Ø 8 ... 40 mm

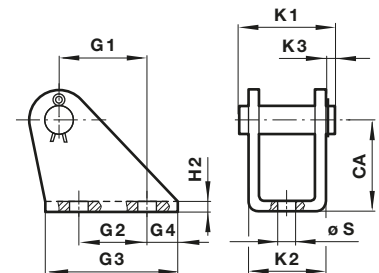

Ø 50 ... 63 mm

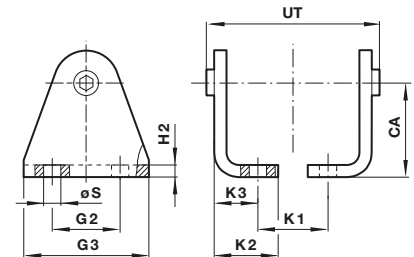

Central trunnion H

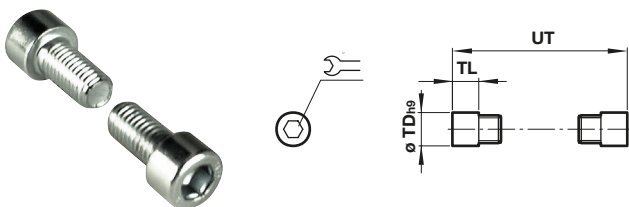

Ø	Ø TD h9	TL	UT	Swivel	kg	Model (H)
50	12	9,5	63	6	0,03	QM/55240/28
63	14	11	76	6	0,05	QM/55250/28

Ø	CA	G 1	2	3	4	H2	K 1	2	3	Ø S	UT	kg	Model (L)
8	10	9	7	14	3,5	1	-	8	-	3,5	-	0,01	QM/57008/24
10/12	12	6,5	-	15	6	1	13,5	10,5	2	4,8	-	0,01	QM/947
16	16	13	10	22	6	1,5	-	12,5	-	4,8	-	0,02	QM/946
20	20	18,5	15	30	8	1,5	20	15	3	5,5	-	0,02	QM/8012/24
25	22	20	15	33	9	2	-	18	-	6,6	-	0,04	QM/57025/24
32	25	20	15	35	10	2	25	20,5	3	6,6	-	0,04	QM/8020/24
40	28	25	20	42	11	3	-	26	-	7	-	0,09	QM/57040/24
50	40	-	30	54	-	4	30,5	24	15	9	68	0,20	QM/57050/24
63	47	-	40	64	-	5	40,5	26,5	17,5	9	84	0,32	QM/57063/24

Nose nut N

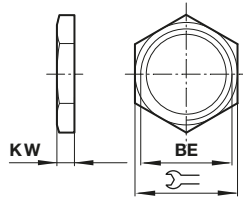

Ø	BE		KW	kg	Model (N)
8...12	M10x1	14	4	0,01	M/P71364
16	M12x1,25	19	6	0,01	M/P1501/90
20	M16x1,5	22	5	0,01	M/P13834
25	M18x1,5	24	5	0,01	M/P13607
32	M22x1,5	27	8	0,02	M/P13615
40	M30x1,5	36	8	0,03	M/P29254

Locknut N2

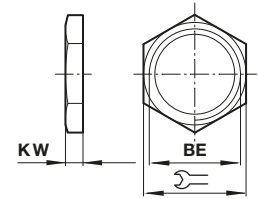

Ø	BE		KW	kg	Model (N)
8	M3	6	2	0,01	M/P1500/111
10/12	M4	7	2	0,01	M/P1501/80
16	M6	10	3	0,01	M/P1501/79
20	M8	13	4	0,01	M/P1501/60
25/32	M10x1,25	17	5	0,01	M/P1501/89
40/50	M12x1,25	19	6	0,01	M/P1501/90
63	M16x1,5	24	8	0,02	M/P1501/91

Universal piston rod eye UF Conforms to DIN ISO 8139

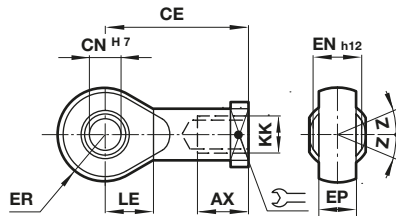

Ø	KK	AX	CE	Ø CN H7	EN -0,1	ER	LE	Z	kg	Model (UF)
10/12	M4	14	27	5	8	8	10	5°	0,02	QM/8010/32
16	M6	14	30	6	9	9	11	5°	0,02	QM/8012/32
20	M8	16	36	8	12	11	13	5°	0,05	QM/8020/32
25/32	M10x1,25	25	42	10	14	14	15	13°	0,08	QM/8025/32
40/50	M12x1,25	22	50	12	16	16	17	13°	0,12	QM/8040/32
63	M16x1,5	28	64	16	21	21	22	15°	0,33	QM/8050/32

Switch mounting brackets - Brackets → 15 mm stroke

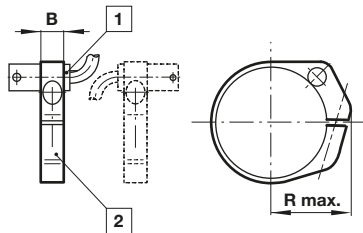

- 1 Magnetically operated switch
- 2 Switch mounting bracket

Ø	B	R max.	kg	Model
10	8	16	0,01	QM/33/010/22
12	8	18	0,01	QM/33/012/22
16	10	20	0,01	QM/33/016/22
20	10	22	0,01	QM/33/020/22
25	10	24	0,01	QM/33/025/22
32	10	29	0,01	QM/33/032/22
40	10	32	0,01	QM/33/040/22
50	10	38	0,01	QM/33/050/22
63	10	46	0,01	QM/33/063/22

Switch mounting brackets - Brackets ← 15 mm stroke

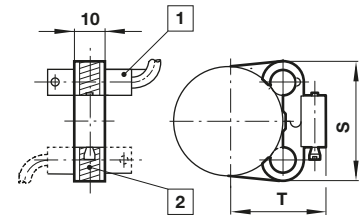

- 1 Magnetically operated switch
- 2 Switch mounting bracket

Ø	S	T	kg	Model
10	27,5	19,5	0,01	QM/33/010/23
12	28,5	21,5	0,01	QM/33/016/23
16	29,5	23,5	0,01	QM/33/016/23
20	29,5	26	0,01	QM/33/020/23
25	31,5	28,5	0,01	QM/33/025/23

Technical data - Reed switches - additional informations see data sheet N/en 4.3.005

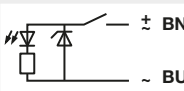
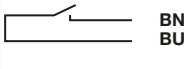
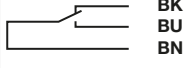
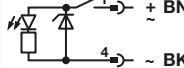
Symbol	Voltage (V a.c.) (V d.c.)	Current maximum (mA)	Function	Operating temperature (°C)	LED	Protection class	Plug	Cable length (m)	Cable type	Weight (g)	Model	
	10 ... 240	10 ... 170	180	Closer	-25 ... +80	•	IP66	—	2, 5 or 10	PVC 2 x 0,25	37	M/50/LSU/*V
	10 ... 240	10 ... 170	180	Closer	-25 ... +80	•	IP66	—	5	PUR 2 x 0,25	37	M/50/LSU/5U
	10 ... 240	10 ... 170	180	Closer	-25 ... +150	—	IP66	—	2	Silicon 2 x 0,25	37	TM/50/RAU/2S
	10 ... 240	10 ... 170	180	Changeover	-25 ... +80	—	IP66	—	5	PVC 3 x 0,25	37	M/50/RAC/5V
	10 ... 60	10 ... 60	180	Closer	-25 ... +80	•	IP66	M8 x 1	0,3	PVC 3 x 0,25	16	M/50/LSU/CP *1)

* Insert cable length; *1) Plug-in connector see page 11; Color code: BK = black, BN = brown, BU = blue

Drawings

M/50/LSU/*V, M/50/LSU/5U,
TM/50/RAU/2S
Cable length L = 2, 5 or 10 m

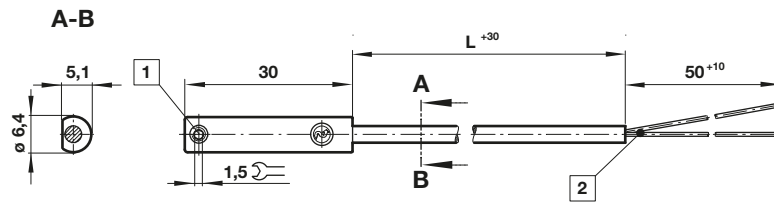

M/50/RAC/5V
Cable length L = 5 m

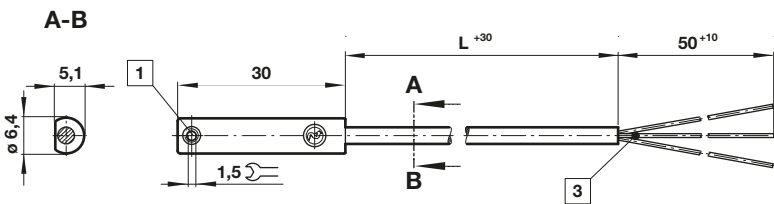

M/50/LSU/CP

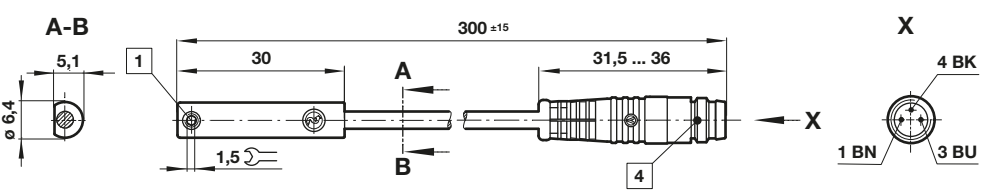

- 1 Fixing screw
- 2 + BN = brown; - BU = blue (output)
- 3 - BK = black; + BN = brown; - BU = blue
- 4 Plug M8 x 1, color code: BK = black; BN = brown; BU = blue

Dimensions in mm
Projection/First angle



Switch mounting brackets - Brackets > 15 mm stroke

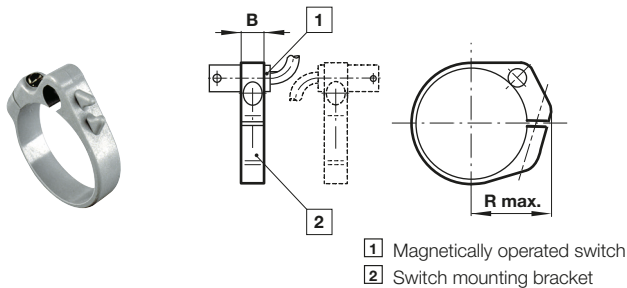

Switch mounting brackets - Brackets < 15 mm stroke

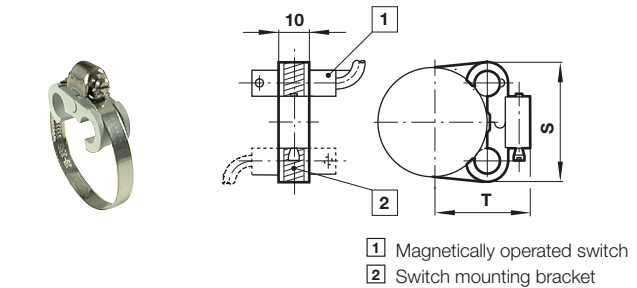

Ø	B	R max.	kg	Model
10	8	16	0,01	QM/33/010/22
12	8	18	0,01	QM/33/012/22
16	10	20	0,01	QM/33/016/22
20	10	22	0,01	QM/33/020/22
25	10	24	0,01	QM/33/025/22

Ø	S	T	kg	Model
10	27,5	19,5	0,01	QM/33/010/23
12	28,5	21,5	0,01	QM/33/016/23
16	29,5	23,5	0,01	QM/33/016/23
20	29,5	26	0,01	QM/33/020/23
25	31,5	28,5	0,01	QM/33/025/23

Technical data - Solid state - additional informations see data sheet N/en 4.3.007

Symbol	Voltage (V d.c.)	Current maximum (mA)	Function	Operating temperature (°C)	LED	Protection class	Plug	Cable length (m)	Cable type	Weight (g)	Model
	10 ... 30	150	PNP	-40 ... +80	•	IP67	—	2, 5 or 10	PVC 3 x 0,12	37	M/50/EAP/*V
	10 ... 30	150	PNP	-40 ... +80	•	IP68	—	5	PUR 3 x 0,14	37	M/50/EAP/5U
	10 ... 30	150	PNP	-40 ... +80	•	IP67	M8 x 1	0,3	PVC 3 x 0,14	16	M/50/EAP/CP *1)
	10 ... 30	150	PNP	-40 ... +80	•	IP67	M12 x 1	0,3	PVC 3 x 0,14	16	M/50/EAP/CC *1)
	10 ... 30	150	NPN	-40 ... +80	•	IP67	—	2, 5 or 10	PVC 3 x 0,12	37	M/50/EAN/*V
	10 ... 30	150	Closer	-40 ... +80	•	IP67	M8 x 1	0,3	PVC 3 x 0,14	16	M/50/EAN/CP *1)

* Insert cable length; *1) Plug-in connector below; Color code: BK = black, BN = brown, BU = blue

Drawings

M/50/EAP/*V,
M/50/EAN/*V
Cable length L = 2, 5 or 10 m

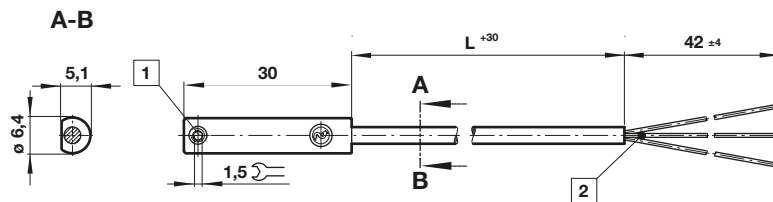

Dimensions in mm
Projection/First angle



M/50/EAP/CP,
M/50/EAN/CP

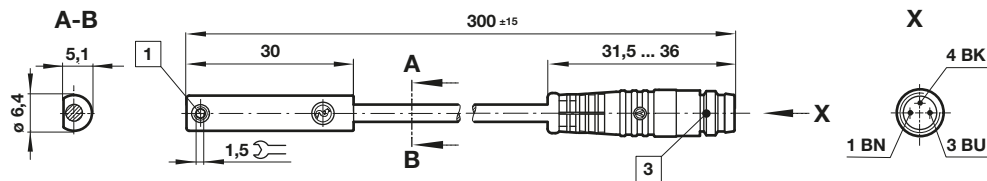

M/50/EAP/CC

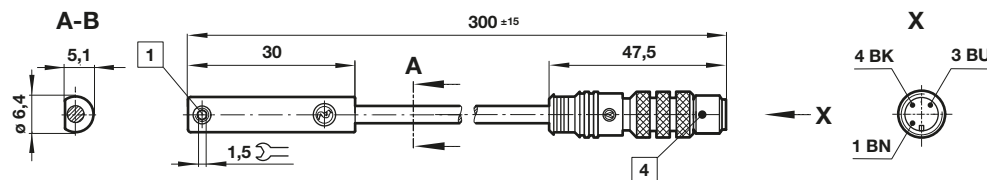

- 1 Fixing screw
- 2 Color code: BK = black; BN = brown; BU = blue
- 3 Plug M8 x 1
- 4 Plug M12 x 1

Accessories

Plug-in connector cable with nut



Outer cover	Cable length (m)	Weight (kg)	Connector	Connector
PVC 3 x 0,25	5 m	0,18	M8 x 1	M/P73001/5
PUR 3 x 0,25	5 m	0,18	M8 x 1	M/P73002/5
PUR 3 x 0,34	5 m	0,21	M12 x 1	M/P34594/5

Warning

These products are intended for use in industrial compressed air systems only. Do not use these products where pressures and temperatures can exceed those listed under

»Technical features/data«.

Before using these products with fluids other than those specified, for non-industrial applications, life-support systems or other applications not within published specifications, consult IMI Precision Engineering, Norgren GmbH. Through misuse, age, or malfunction, components used in fluid power systems can fail in various modes.

The system designer is warned to consider the failure modes of all component parts used in fluid power systems and to provide adequate safeguards to prevent personal injury or damage to equipment in the event of such failure.

System designers must provide a warning to end users in the system instructional manual if protection against a failure mode cannot be adequately provided.

System designers and end users are cautioned to review specific warnings found in instruction sheets packed and shipped with these products.