

- > **Port size:**  
M5, G1/8 ... G1/2
- > **Compact size/low weight/ in-line units**
- > **High flow performance**
- > **Suitable for panel and wall mounting**
- > **Adjustment can be locked**
- > **Captive regulator needle will not blow out when unscrewed**
- > **Adjusting knob position line**



### Technical features

#### Medium:

Compressed air, filtered, lubricated or non-lubricated, inert gases

#### Operation:

Flow regulators (uni-directional)

#### Operating pressure:

1 ... 10 bar (14 ... 145 psi)  
(0,3 ... 10 bar (4 ... 145 psi) for M5)

#### Port size:

M5, G1/8, G1/4, G3/8, G1/2

#### Ambient/Media temperature:

-20 ... +80°C max.  
(-4 ... +176°F)

Air supply must be dry enough to avoid ice formation at temperatures below +2°C (+35°F).

#### Materials:

Body: Aluminium alloy  
Needle & internal parts: Brass  
External parts: Aluminium alloy  
Seals: NBR

### Technical data, standard models

Symbol	Port size	Max. regulated flow factor			Free flow factor			Opening pressure (bar)	Weight (kg)	Model
		C *1)	Cv	Kv *2)	C *1)	Cv	Kv *2)			
	M5	0,28	0,07	0,06	0,28	0,07	0,06	0,3	0,020	T1000M0500
	G1/8	0,57	0,14	0,12	1,50	0,37	0,32	< 0,1	0,031	T1000C1800
	G1/4	1,30	0,32	0,28	2,80	0,69	0,6	< 0,1	0,056	T1000C2800
	G3/8	4,80	1,17	1,62	6,70	1,64	1,43	< 0,1	0,150	T1000C3800
	G1/2	7,50	1,84	1,6	8,30	2,00	1,77	< 0,1	0,180	T1000C4800

\*1) Measured in dm<sup>3</sup>/(s.bar)

\*2) Measured in m<sup>3</sup>/h

### Option selector

**T1000★ ★ ★ 00**

Thread form	Substitute
Metric, M5 only	<b>M</b>
ISO G	<b>C</b>
NPT	<b>A</b>

Port size	Substitute
M5	<b>05</b>
1/8"	<b>18</b>
1/4"	<b>28</b>
3/8"	<b>38</b>
1/2"	<b>48</b>

Flow vs turns at 6 bar – flow in dm<sup>3</sup>/s ANR

T1000M0500

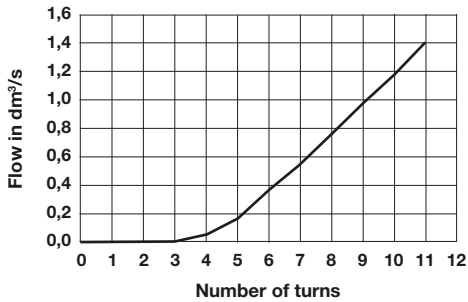

T1000C1800

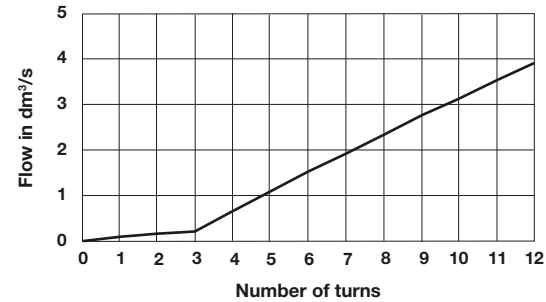

T1000C2800

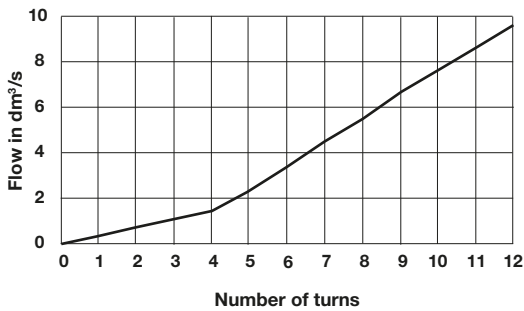

T1000C3800

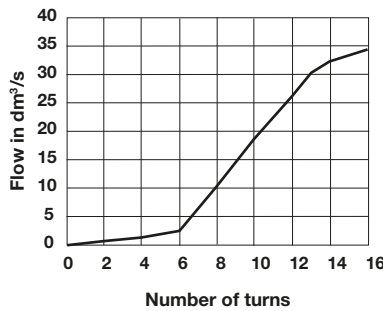

T1000C4800

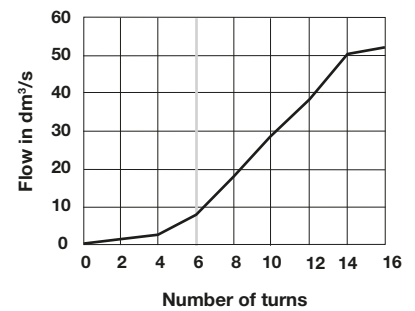

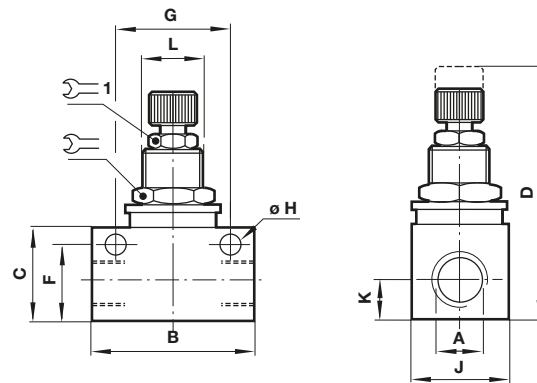

Dimensions



Dimensions in mm  
Projection/First angle



A	B	C	D	F	G	H	J	K	L			Panel-hole	Max. panel thickness	Model
M5	25,0	15,0	45,0	12,0	18,0	4,5	12,0	5,5	M10x0,75	12	8	10,5	4,0	T1000M0500
G1/8	34,0	20,0	51,0	16,5	24,0	4,5	16,0	8,0	M12x1	14	∅ 10,5	12,5	4,0	T1000C1800
G1/4	45,0	25,5	61,5	21,0	32,0	4,5	19,0	9,5	M14x1	17	∅ 10,5	14,5	4,0	T1000C2800
G3/8	58,0	32,5	78,5	27,0	43,0	6,5	28,0	13,0	M20x1	24	14	20,5	4,0	T1000C3800
G1/2	65,0	36,0	82,0	30,5	50,0	6,5	30,0	15,0	M20x1	24	14	20,5	4,0	T1000C4800

Warning

These products are intended for use in industrial compressed air systems only. Do not use these products where pressures and temperatures can exceed those listed under »**Technical features/data**«.

Before using these products with fluids other than those specified, for non-industrial applications, life-support systems or other applications not within published specifications, consult IMI Precision Engineering, Norgren Ltd.

Through misuse, age, or malfunction, components used in fluid power systems can fail in various modes. The system designer is warned to consider the failure modes of all component parts used in fluid power systems and to provide adequate safeguards to prevent personal injury or damage to equipment in the event of such failure.

System designers must provide a warning to end users in the system instructional manual if protection against a failure mode cannot be adequately provided.

System designers and end users are cautioned to review specific warnings found in instruction sheets packed and shipped with these products.