

Check valve type ER and EK

Product documentation



Plug-in valve

Operating pressure p_{\max} :

700 bar

Flow rate Q_{\max} :

120 lpm



© by HAWE Hydraulik SE.

The reproduction and distribution of this document as well as the use and communication of its contents to others without explicit authorisation is prohibited.

Offenders will be held liable for the payment of damages.

All rights reserved in the event of patent or utility model applications.

Brand names, product names and trademarks are not specifically indicated. In particular with regard to registered and protected names and trademarks, usage is subject to legal provisions.

HAWE Hydraulik respects these legal provisions in all cases.

Printing date / document generated on: 07.01.2019

Contents

1	Overview of insert check valves type ER and EK.....	4
2	Available versions, main data.....	5
3	Parameters.....	6
4	Dimensions.....	8
5	Assembly, operation and maintenance recommendations.....	10
5.1	Intended use.....	10
5.2	Assembly information.....	10
5.2.1	Installation information.....	11
5.2.2	Creating the mounting hole.....	11
5.3	Operating instructions.....	12
5.4	Maintenance information.....	12

Check valves are a type of non-return valve. They block the oil flow in one direction and open in the opposite direction. In the closed state they have zero leakage.

The check valve type ER can be plugged in. The spring-loaded ball check valve type ER is very robust and insensitive to soiling.

Type ER can be integrated directly in valves for manifold mounting. As such an additional intermediate plate is not necessary for the check valve function.



Insert check valve ER

Features and benefits:

- Operating pressures up to 700 bar
- Easily machined mounting holes
- robust and dirt resistance

Intended applications:

- Mobile hydraulics
- Industrial hydraulics

2 Available versions, main data

Circuit symbol:



Order coding example:

ER 01
 EK 01

Basic type and size Table 1 Basic type and size

Table 1 Basic type and size

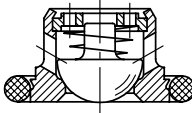
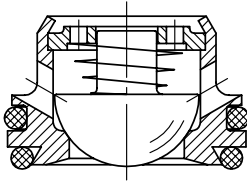
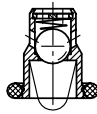
Basic type and size	Flow rate Q (lpm)	Pressure p_{max} (bar)	Opening pressure (bar)	Section view
ER 01	6	700	0.4 to 0.5	
ER 11 ER 12 ER 13	12	700	0.4 to 0.5	
ER 21	30	700	0.4 to 0.5	
ER 31	65	500	0.4 to 0.5	
ER 41	120	400	0.4 to 0.5	
EK 01	10	500	0.6	

General

Designation	Check valve
Design	Ball seated valve
Model	Plug-in valve
Material	Steel; hardened, ground functional inner parts V2A
Installation position	As desired
Hydraulic fluid	Hydraulic oil: according to part 1 to 3; ISO VG 10 to 68 according to DIN ISO 3448 Viscosity limits: min. approx. 4, max. approx. 1500 mm ² /s opt. operation approx. 10... 500 mm ² /s. Also suitable for biologically degradable hydraulic fluids type HEPG (polyalkylene glycol) and HEES (synthetic ester) at operating temperatures up to approx. +70°C.
cleanliness level	ISO 4406 <hr/> 21/18/15...19/17/13
Temperatures	Ambient: approx. -40 ... +80°C, Fluid: -25 ... +80°C, Note the viscosity range! Permissible temperature during start: -40°C (observe start-viscosity!), as long as the service temperature is at least 20K higher for the following operation. Biologically degradable pressure fluids: Observe manufacturer's specifications. By consideration of the compatibility with seal material not over +70°C.

Characteristic curves

Oil viscosity approx. 50 mm²/s

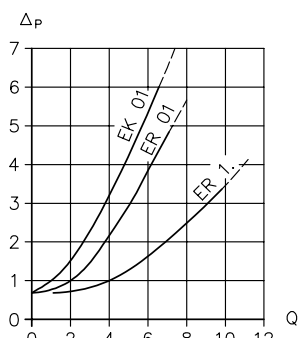

Q flow rate (lpm); Δp flow resistance (bar)

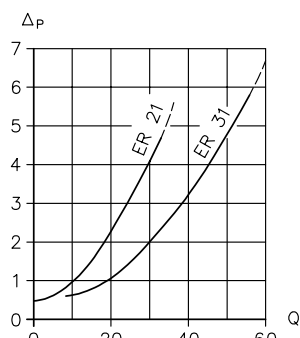

Q flow rate (lpm); Δp flow resistance (bar)

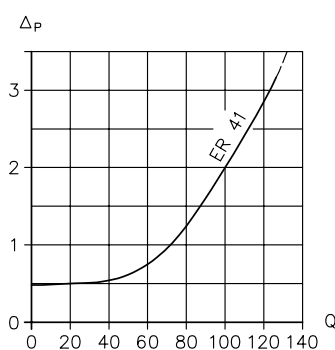

Q flow rate (lpm); Δp flow resistance (bar)

Weight

Type

ER 01	= 0.5 g
ER 11, ER 12, ER 13	= 1 g
ER 21	= 5 g
ER 31	= 9 g
ER 41	= 40 g
EK 01	= 1 g

4 Dimensions

All dimensions in mm, subject to change.

Unit dimensions, mounting holes

EK 01

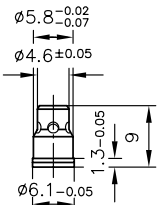
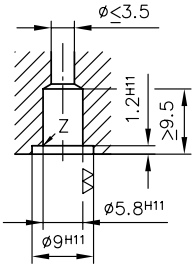

O-ring 6x1.5 NBR 90 Sh

ER 01

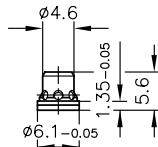
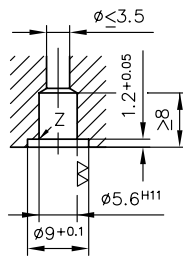

O-ring 6x1.5 NBR 90 Sh

ER 11

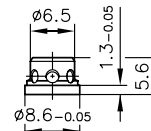
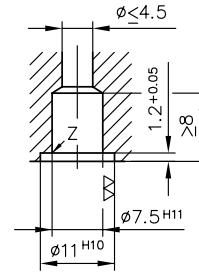

O-ring 8x1.5 NBR 90 Sh

ER 12

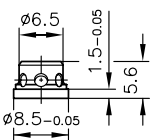
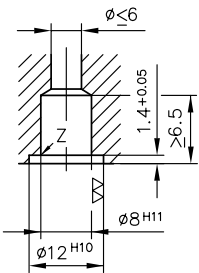

O-ring 8.73x1.78 NBR 90 Sh

ER 13

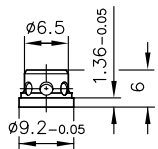
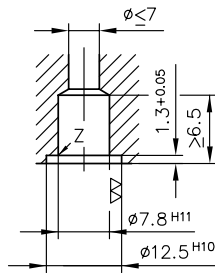

O-ring 9.25x1.78 NBR 90 Sh

ER 21

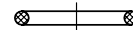
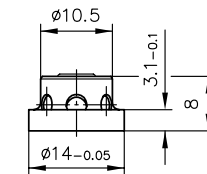
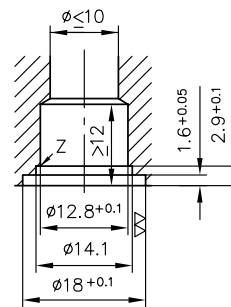

O-ring 14x2 NBR 90 Sh

ER 31

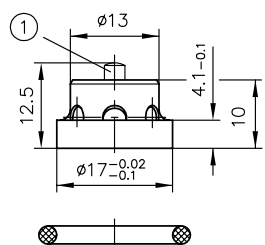
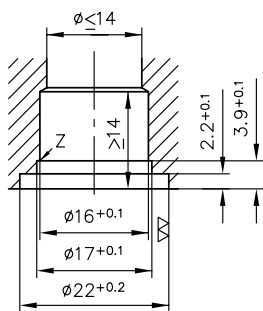

1 Valve guide pin, fully open

O-ring 17.12x2.62 NBR 90 Sh

ER 41

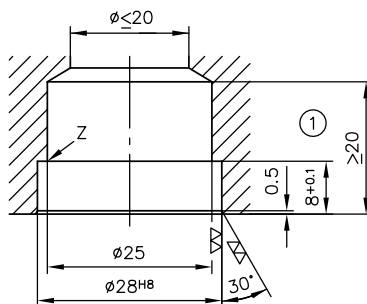

1 Reaming depth 7

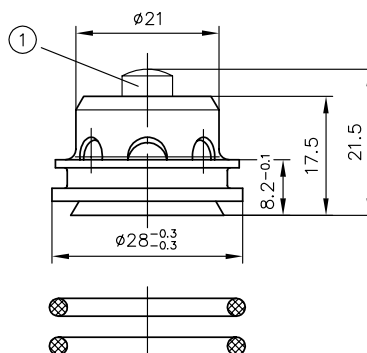

1 Valve guide pin, fully open

O-ring 23.47x2.62 NBR 90 Sh

i NOTE

Z = sharp edge, free of burrs; remaining holes 0.2 broken

5.1 Intended use

This valve is intended exclusively for hydraulic applications (fluid technology).

The user must observe the safety measures and warnings in this documentation.

Essential requirements for the product to function correctly and safely:

- All information in this documentation must be observed. This applies in particular to all safety measures and warnings.
- The product must only be assembled and put into operation by qualified personnel.
- The product must only be operated within the specified technical parameters. The technical parameters are described in detail in this documentation.
- The operating and maintenance manual of the components, assemblies and the specific complete system must also always be observed.

If the product can no longer be operated safely:

1. Remove the product from operation and mark it accordingly.
- ✓ It is then not permitted to continue using or operating the product.

5.2 Assembly information

The product must only be installed in the complete system with standard and compliant connection components (fittings, hoses, pipes, fixtures, etc.).

The product must be shut down correctly prior to dismantling (in particular in combination with hydraulic accumulators).



DANGER

Risk to life caused by sudden movement of the hydraulic drives when dismantled incorrectly!

Risk of serious injury or death.

- Depressurise the hydraulic system.
- Perform safety measures in preparation for maintenance.

5.2.1 Installation information

The insert check valve is precisely fixed in the holder by means of a deliberate slight plastic deformation on the marked contact edge when the fastening screws are tightened. This assembly requirement calls for the material of the holder to be fluid. All common hydraulic valve mounting materials may be used, with the exception of hardened or self-hardening materials.

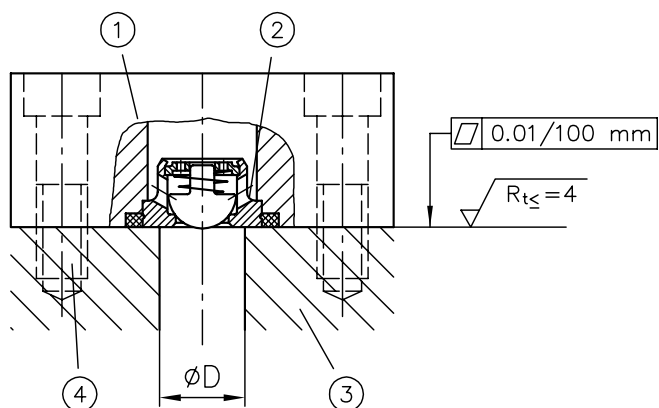

- 1 Holder
- 2 Slight plastic deformation on the contact edge
- 3 Base plate
- 4 Tighten fastening screws equally until the joint between the holder and base plate is completely closed.

Type	Connection bore $\varnothing D$
EK 01	3.5
ER 01	3.5
ER 11	4.5
ER 12	6
ER 13	7
ER 21	10
ER 31	14
ER 41	20

5.2.2 Creating the mounting hole

See description in [Chapter 4, "Dimensions"](#).

5.3 Operating instructions

Note product configuration and pressure / flow rate

The statements and technical parameters in this documentation must be strictly observed.
The instructions for the complete technical system must also always be followed.

i NOTE

- Read the documentation carefully before usage.
- The documentation must be accessible to the operating and maintenance staff at all times.
- Keep documentation up to date after every addition or update.

Purity and filtering of the hydraulic fluid

Fine contamination can significantly impair the function of the hydraulic component. Contamination can cause irreparable damage.

Examples of fine contamination include:

- Metal chips
- Rubber particles from hoses and seals
- Dirt due to assembly and maintenance
- Mechanical debris
- Chemical ageing of the hydraulic fluid

i NOTE

Fresh hydraulic fluid from the drum does not always have the highest degree of purity. Under some circumstances the fresh hydraulic fluid must be filtered before use.

Adhere to the cleanliness level of the hydraulic fluid in order to maintain faultless operation.
(also see cleanliness level in [Chapter 3, "Parameters"](#)).

Additionally applicable document: [D 5488/1](#) Oil recommendations

5.4 Maintenance information

Conduct a visual inspection at regular intervals, but at least once per year, to check if the hydraulic connections are damaged. If external leakages are found, shut down and repair the system.

Clean the device surface of dust deposits and dirt at regular intervals, but at least once per year.

Further information

Additional versions

- Check valves, type RC: D 6969 R
- Check valve type RK and RB: D 7445
- Check valve type CRK, CRB and CRH: D 7712
- Check valves, type B: D 1191
- Orifice type EB: D 6465

Application

- Directional seated valve type G, WG and others: D 7300
- Valve bank (directional seated valve) type VB: D 7302
- Directional seated valve type WN and WH: D 7470 A/1
- Valve bank (directional seated valve) type BWN and BWH: D 7470 B/1