

Shuttle valve type WV and WVC

Product documentation

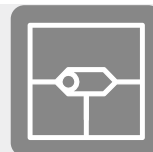

Operating pressure p_{\max} :

700 bar

Flow rate Q_{\max} :

125 lpm



© by HAWE Hydraulik SE.

The reproduction and distribution of this document as well as the use and communication of its contents to others without explicit authorisation is prohibited.

Offenders will be held liable for the payment of damages.

All rights reserved in the event of patent or utility model applications.

Brand names, product names and trademarks are not specifically indicated. In particular with regard to registered and protected names and trademarks, usage is subject to legal provisions.

HAWE Hydraulik respects these legal provisions in all cases.

Printing date / document generated on: 14.11.2018

Contents

1	Overview of shuttle valve type WV and WVC.....	4
2	Available versions, main data.....	5
3	Parameters.....	6
3.1	General data.....	6
4	Dimensions.....	9
4.1	Insert valves.....	9
4.2	Screw-in valves.....	10
4.3	Locking tapped plugs.....	11
5	Assembly, operation and maintenance recommendations.....	12
5.1	Intended use.....	12
5.2	Assembly information.....	12
5.2.1	Creating the mounting hole.....	12
5.3	Operating instructions.....	13
5.4	Maintenance information.....	13
6	Other information.....	14

Shuttle valves are a type of check valve. They have two inlets and one outlet. As soon as a pressure signal is present on at least one of the two inlets, an outlet signal is generated. The inlet with the higher pressure is automatically connected to the outlet. The other inlet with lower pressure is blocked by a ball (OR operator).

The shuttle valve type WV is integrated in a T-fitting for pipe connection. The type WVC is a screw-in valve. The shuttle valves can withstand pressures up to 700 bar and have low flow resistances.

They can be used for transmitting control pressures or control and operating volumetric flows.



Shuttle valve

Features and benefits:

- Pressures up to 700 bar
- Insert and housing versions

Intended applications:

- Load sensing systems
- Construction and construction materials machinery
- Cranes and lifting equipment
- Road vehicle
- General mobile hydraulics

2 Available versions, main data

Circuit symbol:

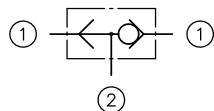

- 1 Inflow
2 Outflow

Order coding example:

WV 10 - S

Basic type and size Table 1 Basic type and size

Table 1 Basic type and size

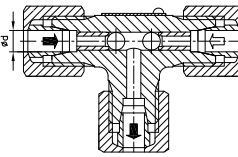
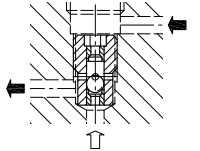
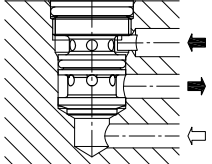
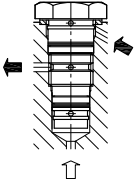
Type	Description	Ød (mm)	Pressure p _{max} (bar)	Flow rate Q _{max} (lpm)	
WV 6 - S	For pipe connection S: heavy series L: light series	6	700	6	
WV 8 - S		8		15	
WV 10 - S		10		25	
WV 12 - S		12	500	40	
WV 14 - S		14	60		
WV 16 - S		16	100		
WV 18 - L		18	315	125	
WVC 1 WVC 11 (with PTFE thread seal)	for screwing in	--	315	6	
WVE 2 *		--	500	25	
WVH 11		--	700	3	

* For alternative locking tapped plug, see [Chapter 4.3, "Locking tapped plugs"](#)

3.1 General data

Designation	Shuttle valve
Design	Ball seated valve
Model	Screw-in valve, pipe connection
Material	Steel; nitrided valve housing, hardened and ground functional inner parts
Tightening torques	See Chapter 4, "Dimensions"
Installation position	as desired
Connections	1- Inflow, 2- Outflow
Hydraulic fluid	Hydraulic oil: according to DIN 51 524 Part 1 to 3; ISO VG 10 to 68 according to DIN 51 519 Viscosity range: min. approx. 4; max. approx. 1500 mm ² /s Optimal operation: approx. 3 x p _{max}
Cleanliness level	ISO 4406 <u>21/18/15...19/17/13</u>
Temperatures	Ambient: approx. -40 ... +80°C, Fluid: -25 ... +80°C, Note the viscosity range! Permissible temperature during start: -40°C (observe start-viscosity!), as long as the service temperature is at least 20K higher for the following operation. Biologically degradable pressure fluids: Observe manufacturer's specifications. By consideration of the compatibility with seal material not over +70°C.
Static overload capacity	> 2x p _{max} Burst pressure: approx. 3 x p _{max}
Flow rate	According to type and size
Operating pressure	According to type and size WVE 2 - AT: p _{max} = 400 bar

Characteristic curves

Oil viscosity approx. 60 mm²/s

Δp -Q characteristics

WV 6-S to WV 16-S, WV 18-L

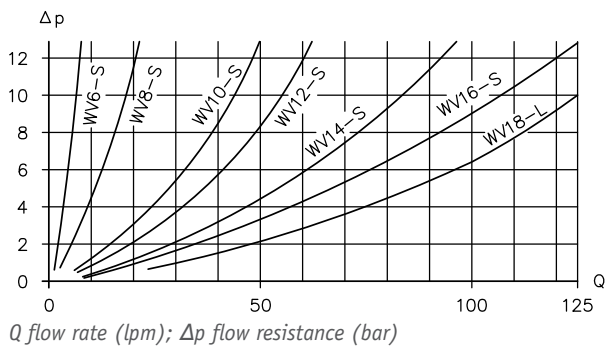

WVC 1, WVC 11

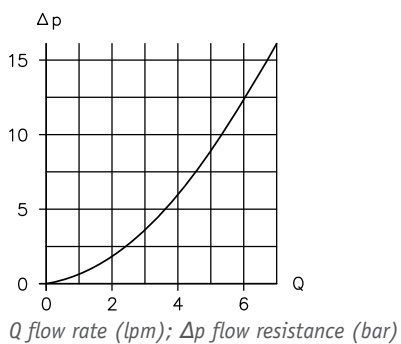

WVE 2

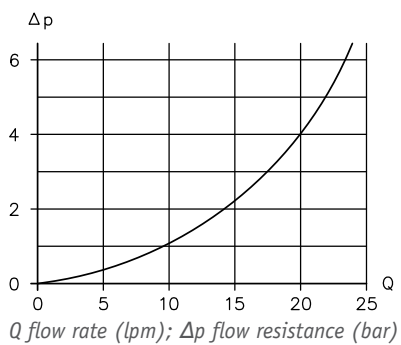

WVH 11

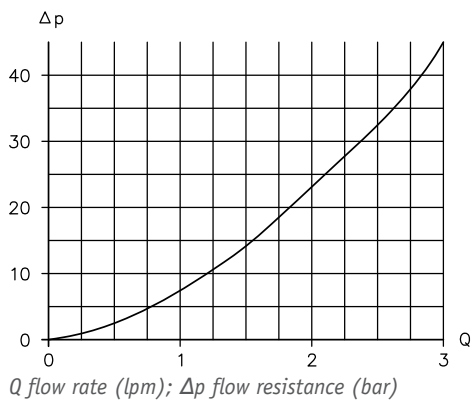

Weight**Basic version****Type**

WV 6-S	= 120 g
WV 8-S	= 170 g
WV 10-S	= 225 g
WV 12-S	= 290 g
WV 14-S	= 320 g
WV 16-S	= 390 g
WV 18-L	= 340 g
WVC 1	= 7 g
WVH 11	= 10 g
WVE 2	= 24 g
WVE 11	= 20 g

4 Dimensions

All dimensions in mm, subject to change.

4.1 Insert valves

WV 6-S to WV 16-S, WV 18-L

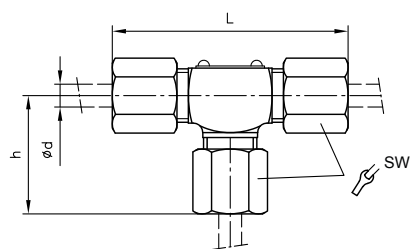

Type	L	h	Ød	SW
WV 6 - S	62	31	6	17
WV 8 - S	64	32	8	19
WV 10 - S	68	34	10	22
WV 12 - S	76	38	12	24
WV 14 - S	80	40	14	27
WV 16 - S	86	43	16	30
WV 18 - L	80	40	18	32

4.2 Screw-in valves

WVC 1

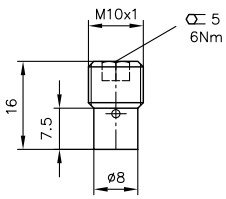

WVC 11

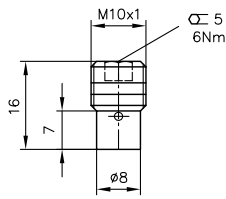

Mounting hole

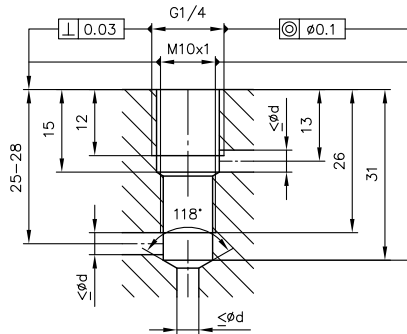

WVE 2

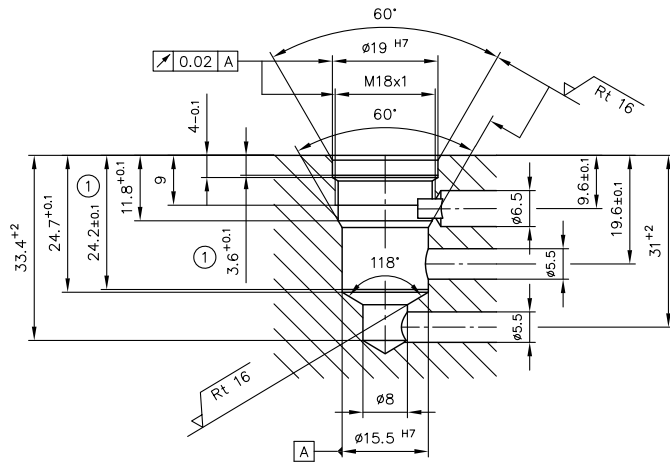
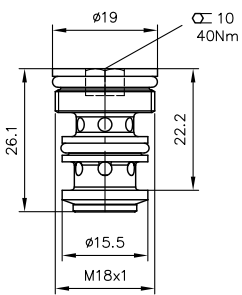

- 1 Reamed depth
- 2 Milling cutter width

WVH 11

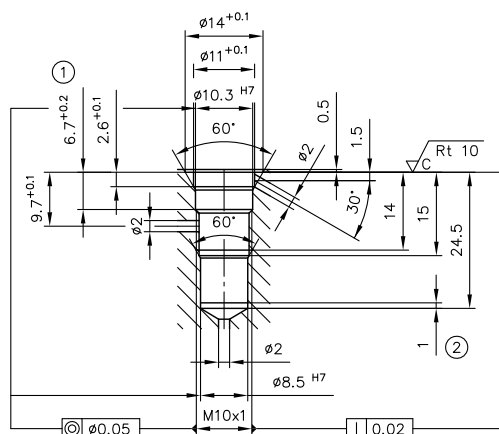
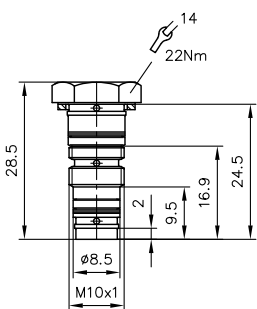

- 1 Reamed depth 6.3
- 2 Reamer lead

5.1 Intended use

This valve is intended exclusively for hydraulic applications (fluid technology).

The user must observe the safety measures and warnings in this documentation.

Essential requirements for the product to function correctly and safely:

- All information in this documentation must be observed. This applies in particular to all safety measures and warnings.
- The product must only be assembled and put into operation by qualified personnel.
- The product must only be operated within the specified technical parameters. The technical parameters are described in detail in this documentation.
- The operating and maintenance manual of the components, assemblies and the specific complete system must also always be observed.

If the product can no longer be operated safely:

1. Remove the product from operation and mark it accordingly.
- ✓ It is then not permitted to continue using or operating the product.

5.2 Assembly information

The product must only be installed in the complete system with standard and compliant connection components (fittings, hoses, pipes, fixtures, etc.).

The product must be shut down correctly prior to dismantling (in particular in combination with hydraulic accumulators).



Danger

Risk to life caused by sudden movement of the hydraulic drives when dismantled incorrectly!

Risk of serious injury or death.

- Depressurise the hydraulic system.
- Perform safety measures in preparation for maintenance.



Note

WVE 11: Ensure that the sealing rings do not shear off!

- ▶ Grease the threaded hole before assembly.
- ▶ Assembly speed ≤ 60 rpm.
- ▶ Carefully remove PTFE chips.

5.2.1 Creating the mounting hole

See description in [Chapter 4, "Dimensions"](#).

5.3 Operating instructions

Note product configuration and pressure / flow rate

The statements and technical parameters in this documentation must be strictly observed.
The instructions for the complete technical system must also always be followed.

Note

- Read the documentation carefully before usage.
- The documentation must be accessible to the operating and maintenance staff at all times.
- Keep documentation up to date after every addition or update.

Purity and filtering of the hydraulic fluid

Fine contamination can significantly impair the function of the hydraulic component. Contamination can cause irreparable damage.

Examples of fine contamination include:

- Metal chips
- Rubber particles from hoses and seals
- Dirt due to assembly and maintenance
- Mechanical debris
- Chemical ageing of the hydraulic fluid

Note

Fresh hydraulic fluid from the drum does not always have the highest degree of purity. Under some circumstances the fresh hydraulic fluid must be filtered before use.

To ensure smooth operation, pay attention to the cleanliness level of the hydraulic fluid.
(also see cleanliness level in [Chapter 3, "Parameters"](#))

Other applicable document: [D 5488/1](#) Oil recommendations

5.4 Maintenance information

Conduct a visual inspection at regular intervals, but at least once per year, to check if the hydraulic connections are damaged. If external leakages are found, shut down and repair the system.

Clean the device surface of dust deposits and dirt at regular intervals, but at least once per year.

6 Other information

Application examples

Mixed remote control of a proportional directional spool valve

(e.g. type PSL and PSV according to D7700 et seqq.) using pressure reducing valves type FB and KFB according to [D 6600-01](#)

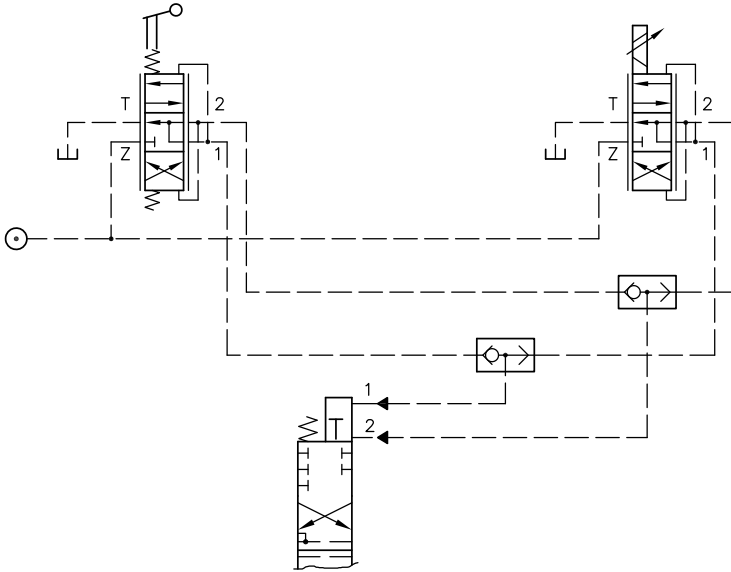

Further information

Further versions

- Line rupture protection valves, type LB: D 6990
- Check valve type CRK, CRB and CRH: D 7712
- Check valve type RK and RB: D 7445
- Check valves, type RC: D 6969 R
- Check valve type RE: D 7555 R